

THIS COPY IS PROVIDED ON A RESTRICTED BASIS AND IS NOT TO BE USED IN ANY WAY DETRIMENTAL TO THE INTERESTS OF PANDUIT CORP.

Material	High Conductivity Seamless Copper Tube
Plating	Electro-Tin
Wire Size	4 STR/FLEX
Wire Type	Stranded Copper: Class B & C, Compact, Class G, H, I, K, M, Sizes 3, 4 & 5 Locomotive
Wire Strip Length	1-1/8 in.
Stud Size	3/8 in.
UL Listed Wire Connector	Yes, for applications up to 35kv. Consult cable manufacturer for voltage stress relief instructions with applications greater than 2000 volts.
UL Temperature Rating	90° C
C.S.A Certified Wire Connector	Yes
Panduit Color Code on Barrel	GRAY
Panduit Die Index No. on Barrel	P29
Alternate Industry Die Index No. ( ) on Barrel	(8)



CERTIFIED



LISTED Wire Connector

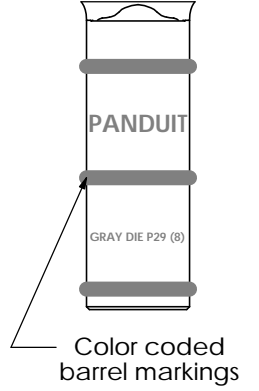
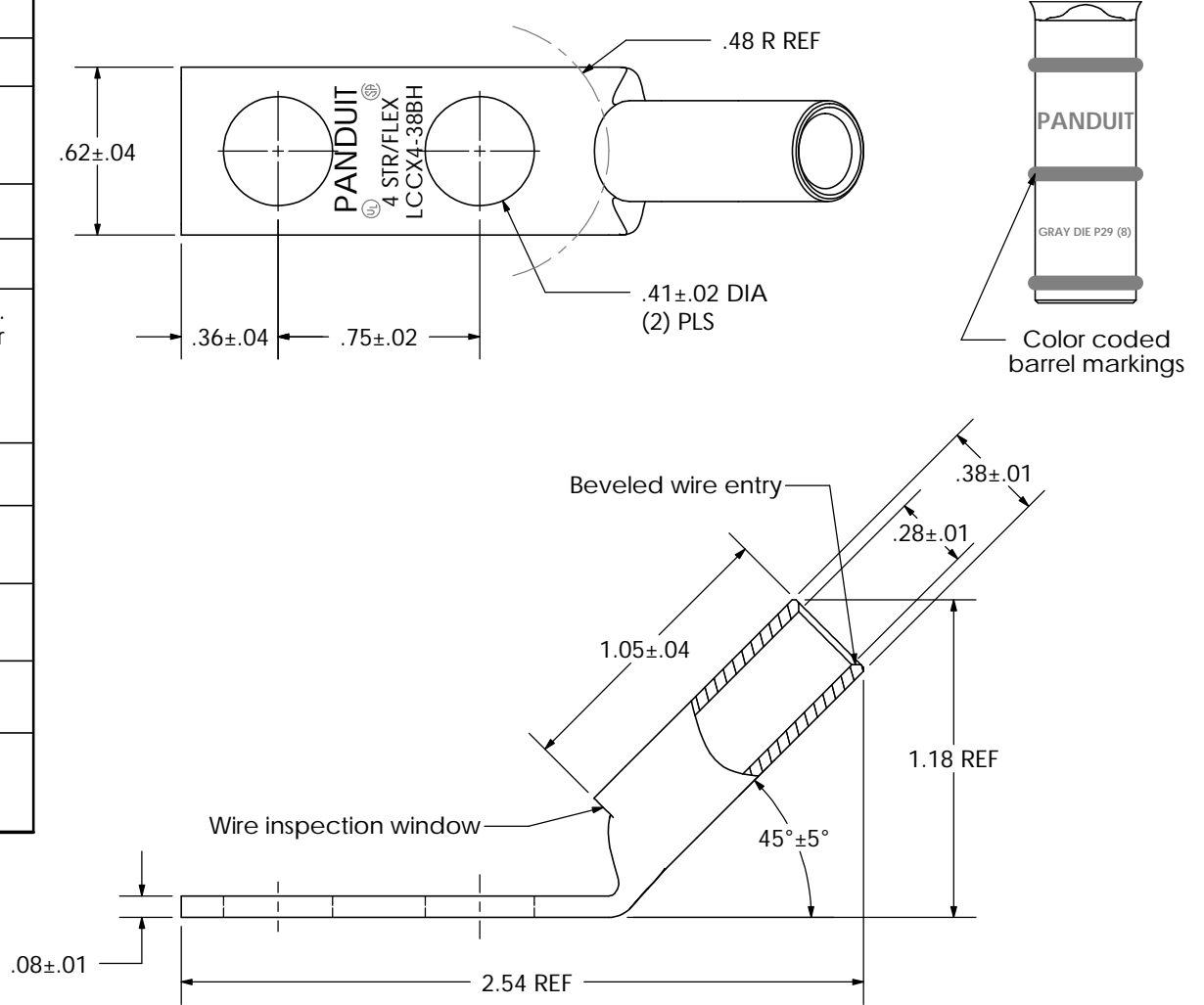

03	1/05	JHNU	TLCO	PANDUIT REPLACED WIRE RANGE ON BARREL MARKING	12412
REV	DATE	BY	CHK	DESCRIPTION	ECN

**PANDUIT CORP.** TINLEY PARK, ILLINOIS

LCCX4-38BH-L  
Copper Lug - Two-Hole, Long Flex Barrel with Window, 45° Angle Tongue

SCALE N/A DRAWING NO / CAD FILE LCCX4-38BH-CUST